

svan

USER MANUAL PORTABLE AIR CONDITIONER

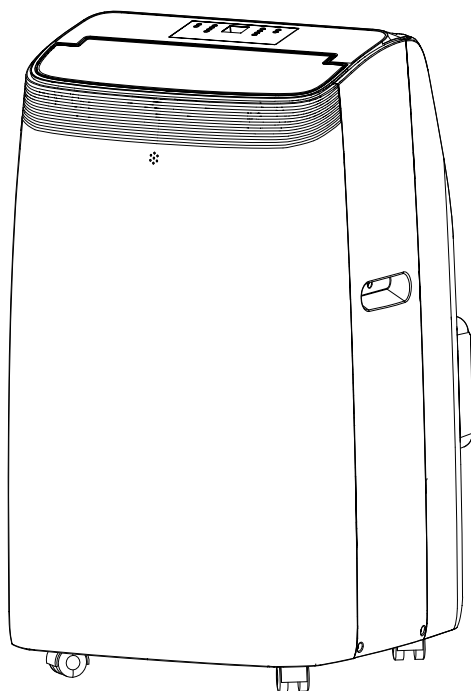

SAAP1200F
SAAP1200B

This appliance is intended for domestic use only.
Read this manual carefully and keep it for future reference.

IMPORTANT SAFEGUARDS

VERY IMPORTANT!

Please do not install or use your appliance before you have carefully read this manual. Please keep this instruction manual for an eventual product warranty and for future reference.

GENERAL SAFETY INSTRUCTION

- 1.The appliance is for indoor use only.
- 2.Do not use the unit on a socket under repairs or not installed properly.
- 3.Do not use the unit, follow these precautions:
A: Near to source of fire.
B: An area where oil is likely to splash.
C: An area exposed to direct sunlight.
D: An area where water is likely to splash.
E: Near a bath, a laundry, a shower or a swimming pool.
- 4.Never insert your fingers, rods into the air outlet. Take special care to warn children of these dangers.
- 5.Keep the unit upward while transport and storage, for the compressor locates properly.
- 6.Before cleaning the appliance, always turn off or disconnect the power supply.
- 7.When moving the appliance, always turn off and disconnect the power supply, and move it slowly.
- 8.To avoid the possibility of fire disaster, the appliance shall not be covered.
- 9.All the appliance sockets must comply with the local electric safety requirements. If necessary, please check it for the requirements.
- 10.Children should be supervised to ensure that they do not play with the appliance.
- 11.If the supply cord is damaged, it must be replaced by the manufacturer, its service agent or similarly qualified persons in order to avoid a hazard.
- 12.This appliance can be used by children aged from 8 years and above and persons with reduced physical, sensory or mental capabilities or lack of experience and knowledge if they have been given supervision or instruction concerning use of the appliance in a safe way and understand the hazards involved. Children shall not play with the appliance. Cleaning and user maintenance shall not be made by children without supervision.
- 13.The appliance shall be installed in accordance with national wiring regulations.
- 14.Details of type and rating of fuses: T, 250V AC, 3.15A .
- 15.Recycling



This marking indicates that this product should not be disposed with other household wastes throughout the EU. To prevent possible harm to the environment or human health from uncontrolled waste disposal, recycle it responsibly to promote the sustainable reuse of material resources. To return your used device, please use the return and collection systems or contact the retailer where the product was purchased. They can take this product for environmental safe recycling.

16. Contact authorized service technician for repair or maintenance of this unit.

17. Do not pull, deform or modify the power supply cord, or immerse it in water. Pulling or misuse of the power supply cord can result in damage to the unit and cause electrical shock.

18. Compliance with national gas regulations shall be observed.

19. Keep ventilation openings clear of obstruction.

20. Any person who is involved with working on or breaking into a refrigerant circuit should hold a current valid certificate from an industry-accredited assessment authority, which authorizes their competence to handle refrigerants safely in accordance with an industry recognized assessment specification.

21. Servicing shall only be performed as recommended by the equipment manufacturer. Maintenance and repair requiring the assistance of other skilled personnel shall be carried out under the supervision of the person competent in the use of flammable refrigerants.

22. Do not operate or stop the unit by inserting or pulling out the power plug, it may cause electric shock or fire due to heat generation.

23. Unplug the unit if strange sounds, smell, or smoke comes from it.

NOTES:

- If any parts damage, please contact the dealer or a designated repair shop;
- In case of any damage, please turn off the air switch, disconnect the power supply, and contact the dealer or a designated repair shop;
- In any case, the power cord shall be firmly grounded;
- To avoid the possibility of danger, if power cord is damaged, please turn off the air switch and disconnect the power supply. It must be replaced from the dealer or a designated repair shop.

WARNING

- Do not use means to accelerate the defrosting process or to clean, other than those recommended by the manufacturer.
- The appliance shall be stored in a room without continuously operating ignition sources (for example: open flames, an operating gas appliance or an operating electric heater).
- Do not pierce or burn.
- Be aware the refrigerants may not contain an odour.
- Appliance shall be installed, operated and stored in a room with a floor area larger than X m².

Quantity of R290 gas in charge (see rating label on the appliance) (g)	Minimum size of the site for use and storage (m ²)
$m < 152$	4
$152 \leq m \leq 185$	9
$186 \leq m \leq 225$	11
$226 \leq m \leq 270$	13
$271 \leq m \leq 290$	14
$291 \leq m \leq 300$	15

SPECIFIC INFORMATION REGARDING APPLIANCES WITH R290 REFRIGERANT GAS.

- Thoroughly read all of the warnings.
- When defrosting and cleaning the appliance, do not use any tools other than those recommended by the manufacturing company.
- The appliance must be placed in an area without any continuously sources of ignition (for example: open flames, gas or electrical appliances in operation).
- Do not puncture and do not burn.
- This appliance contains Y g (see rating label back of unit) of R290 refrigerant gas.
- R290 is a refrigerant gas that complies with the European directives on the environment. Do not puncture any part of the refrigerant circuit.
- If the appliance is installed, operated or stored in an unventilated area, the room must be designed to prevent to the accumulation of refrigerant leaks resulting in a risk of fire or explosion due to ignition of the refrigerant caused by electric heaters, stoves, or other sources of ignition.
- The appliance must be stored in such a way as to prevent mechanical failure.
- Individuals who operate or work on the refrigerant circuit must have the appropriate certification issued by an accredited organization that ensures competence in handling refrigerants according to a specific evaluation recognized by associations in the industry.
- Repairs must be performed based on the recommendation from the manufacturing company. Maintenance and repairs that require the assistance

of other qualified personnel must be performed under the supervision of an individual specified in the use of flammable refrigerants.

- Ducts connected to an appliance shall not contain a potential ignition source.



Caution, risk of fire

INSTRUCTIONS FOR REPAIRING APPLIANCES CONTAINING R290

1 GENERAL INSTRUCTIONS

1.1 Checks to the area

Prior to beginning work on systems containing flammable refrigerants, safety checks are necessary to ensure that the risk of ignition is minimised. For repair to the refrigerating system, the following precautions shall be complied with prior to conducting work on the system.

1.2 Work procedure

Work shall be undertaken under a controlled procedure so as to minimise the risk of a flammable gas or vapour being present while the work is being performed.

1.3 General work area

All maintenance staff and others working in the local area shall be instructed on the nature of work being carried out. Work in confined spaces shall be avoided. The area around the workspace shall be sectioned off. Ensure that the conditions within the area have been made safe by control of flammable material.

1.4 Checking for presence of refrigerant

The area shall be checked with an appropriate refrigerant detector prior to and during work, to ensure the technician is aware of potentially flammable atmospheres. Ensure that the leak detection equipment being used is suitable for use with flammable refrigerants, i.e. nonsparking, adequately sealed or intrinsically safe.

1.5 Presence of fire extinguisher

If any hot work is to be conducted on the refrigeration equipment or any associated parts, appropriate fire extinguishing equipment shall be available to hand. Have a dry powder or CO₂ fire extinguisher adjacent to the charging area.

1.6 No ignition sources

No person carrying out work in relation to a refrigeration system which involves exposing any pipe work that contains or has contained flammable refrigerant shall use any sources of ignition in such a manner that it may lead to the risk of fire or explosion. All possible ignition sources, including cigarette smoking, should be kept sufficiently far away from the site of installation, repairing, removing and disposal, during which flammable refrigerant can possibly be released to the surrounding space. Prior to work taking place, the area around the equipment is to be surveyed to make sure that there are no flammable hazards or ignition risks. "No Smoking" signs shall be displayed.

1.7 Ventilated area

Ensure that the area is in the open or that it is adequately ventilated before breaking into the system or conducting any hot work. A degree of ventilation shall continue during the period that the work is carried out. The ventilation should safely disperse any released refrigerant and preferably expel it externally into the atmosphere.

1.8 Checks to the refrigeration equipment

Where electrical components are being changed, they shall be fit for the purpose and to the correct specification. At all times the manufacturer's maintenance and service guidelines shall be followed. If in doubt consult the manufacturer's technical department for assistance. The following checks shall be applied to installations using flammable refrigerants: the charge size is in accordance with the room size within which the refrigerant containing parts are installed; the ventilation machinery and outlets are operating adequately and are not obstructed; if an indirect refrigerating circuit is being used, the secondary circuit shall be checked for the presence of refrigerant; marking to the equipment continues to be visible and legible. Markings and signs that are illegible shall be corrected; refrigeration pipe or components are installed in a position where they are unlikely to be exposed to any substance which may corrode refrigerant containing components, unless the components are constructed of materials which are inherently resistant to being corroded or are suitably protected against being so corroded.

1.9 Checks to electrical devices

Repair and maintenance to electrical components shall include initial safety checks and component inspection procedures. If a fault exists that could

compromise safety, then no electrical supply shall be connected to the circuit until it is satisfactorily dealt with. If the fault cannot be corrected immediately but it is necessary to continue operation, an adequate temporary solution shall be used. This shall be reported to the owner of the equipment so all parties are advised.

Initial safety checks shall include: that capacitors are discharged: this shall be done in a safe manner to avoid possibility of sparking; that there no live electrical components and wiring are exposed while charging, recovering or purging the system; that there is continuity of earth bonding.

2 REPAIRS TO SEALED COMPONENTS

2.1 During repairs to sealed components, all electrical supplies shall be disconnected from the equipment being worked upon prior to any removal of sealed covers, etc. If it is absolutely necessary to have an electrical supply to equipment during servicing, then a permanently operating form of leak detection shall be located at the most critical point to warn of a potentially hazardous situation.

2.2 Particular attention shall be paid to the following to ensure that by working on electrical components, the casing is not altered in such a way that the level of protection is affected.

This shall include damage to cables, excessive number of connections, terminals not made to original specification, damage to seals, incorrect fitting of glands, etc. Ensure that apparatus is mounted securely. Ensure that seals or sealing materials have not degraded such that they no longer serve the purpose of preventing the ingress of flammable atmospheres. Replacement parts shall be in accordance with the manufacturer's specifications.

NOTE: The use of silicon sealant may inhibit the effectiveness of some types of leak detection equipment. Intrinsically safe components do not have to be isolated prior to working on them.

3 REPAIR TO INTRINSICALLY SAFE COMPONENTS

Do not apply any permanent inductive or capacitance loads to the circuit without ensuring that this will not exceed the permissible voltage and current permitted for the equipment in use.

Intrinsically safe components are the only types that can be worked on while live in the presence of a flammable atmosphere. The test apparatus shall be at the correct rating. Replace components only with parts specified by the manufacturer. Other parts may result in the ignition of refrigerant in the atmosphere from a leak.

4 CABLING

Check that cabling will not be subject to wear, corrosion, excessive pressure, vibration, sharp edges or any other adverse environmental effects. The check shall also take into account the effects of aging or continual vibration from sources such as compressors or fans.

5 DETECTION OF FLAMMABLE REFRIGERANTS

Under no circumstances shall potential sources of ignition be used in the searching for or detection of refrigerant leaks. A halide torch (or any other detector using a naked flame) shall not be used.

6 LEAK DETECTION METHODS

The following leak detection methods are deemed acceptable for systems containing flammable refrigerants. Electronic leak detectors shall be used to detect flammable refrigerants, but the sensitivity may not be adequate, or may need recalibration. (Detection equipment shall be calibrated in a refrigerant-free area.) Ensure that the detector is not a potential source of ignition and is suitable for the refrigerant used. Leak detection equipment shall be set at a percentage of the LFL of the refrigerant and shall be calibrated to the refrigerant employed and the appropriate percentage of gas (25 % maximum) is confirmed. Leak detection fluids are suitable for use with most refrigerants but the use of detergents containing chlorine shall be avoided as the chlorine may react with the refrigerant and corrode the copper pipe-work. If a leak is suspected, all naked flames shall be removed/extinguished. If a leakage of refrigerant is found which requires brazing, all of the refrigerant shall be recovered from the system, or isolated (by means of shut off valves) in a part of the system remote from the leak. Oxygen free nitrogen (OFN) shall then be purged through the system both before and during the brazing process.

7 REMOVAL AND EVACUATION

When breaking into the refrigerant circuit to make repairs – or for any other purpose – conventional procedures shall be used. However, it is important that best practice is followed since flammability is a consideration. The following procedure shall be adhered to: remove refrigerant; purge the circuit with inert gas; evacuate; purge again with inert gas; open the circuit by cutting or brazing. The refrigerant charge shall be recovered into the correct recovery cylinders. The system shall be “flushed” with OFN to render the unit safe. This process may need to be repeated several times. Compressed air or oxygen shall not be used for this task. Flushing shall be achieved by breaking the vacuum in the system with OFN and continuing to fill until the working pressure is achieved, then venting to atmosphere, and finally pulling down to a vacuum.

This process shall be repeated until no refrigerant is within the system. When the final OFN charge is used, the system shall be vented down to atmospheric pressure to enable work to take place. This operation is absolutely vital if brazing operations on the pipework are to take place.

Ensure that the outlet for the vacuum pump is not close to any ignition sources and there is ventilation available.

8 CHARGING PROCEDURES

In addition to conventional charging procedures, the following requirements shall be followed.

- Ensure that contamination of different refrigerants does not occur when using charging equipment. Hoses or lines shall be as short as possible to minimise the amount of refrigerant contained in them.
- Cylinders shall be kept upright.
- Ensure that the refrigeration system is earthed prior to charging the system with refrigerant.
- Label the system when charging is complete (if not already).
- Extreme care shall be taken not to overfill the refrigeration system.

Prior to recharging the system it shall be pressure tested with OFN. The system shall be leak tested on completion of charging but prior to commissioning. A follow up leak test shall be carried out prior to leaving the site.

9 DECOMMISSIONING

Before carrying out this procedure, it is essential that the technician is completely familiar with the equipment and all its detail. It is recommended good practice that all refrigerants are recovered safely. Prior to the task being carried out, an oil and refrigerant sample shall be taken in case analysis is required prior to re-use of reclaimed refrigerant. It is essential that electrical power is available before the task is commenced.

- a) Become familiar with the equipment and its operation.
- b) Isolate system electrically.
- c) Before attempting the procedure ensure that :mechanical handling equipment is available, if required, for handling refrigerant cylinders; all personal protective equipment is available and being used correctly; the recovery process is supervised at all times by a competent person; recovery equipment and cylinders conform to the appropriate standards.
- d) Pump down refrigerant system, if possible.
- e) If a vacuum is not possible, make a manifold so that refrigerant can be removed from various parts of the system.
- f) Make sure that cylinder is situated on the scales before recovery takes place.
- g) Start the recovery machine and operate in accordance with manufacturer's instructions.
- h) Do not overfill cylinders. (No more than 80 % volume liquid charge).

- i) Do not exceed the maximum working pressure of the cylinder,even temporarily.
- j) When the cylinders have been filled correctly and the process completed, make sure that the cylinders and the equipment are removed from site promptly and all isolation valves on the equipment are closed off.
- k) Recovered refrigerant shall not be charged into another refrigeration system unless it has been cleaned and checked.

10 LABELLING

Equipment shall be labelled stating that it has been decommissioned and emptied of refrigerant.The label shall be dated and signed.

Ensure that there are labels on the equipment stating the equipment contains flammable refrigerant.

11 RECOVERY

When removing refrigerant from a system, either for servicing or decommissioning, it is recommended good practice that all refrigerants are removed safely. When transferring refrigerant into cylinders, ensure that only appropriate refrigerant recovery cylinders are employed. Ensure that the correct number of cylinders for holding the total system charge are available.All cylinders to be used are designated for the recovered refrigerant and labelled for that refrigerant (i.e. special cylinders for the recovery of refrigerant). Cylinders shall be complete with pressure relief valve and associated shut-off valves in good working order. Empty recovery cylinders are evacuated and, if possible, cooled before recovery occurs.

The recovery equipment shall be in good working order with a set of instructions concerning the equipment that is at hand and shall be suitable for the recovery of flammable refrigerants.In addition,a set of calibrated weighing scales shall be available and in good working order. Hoses shall be complete with leak-free disconnect couplings and in good condition. Before using the recovery machine, check that it is in satisfactory working order, has been properly maintained and that any associated electrical components are sealed to prevent ignition in the event of a refrigerant release. Consult manufacturer if in doubt.

The recovered refrigerant shall be returned to the refrigerant supplier in the correct recovery cylinder,and the relevant Waste Transfer Note arranged. Do not mix refrigerants in recoveryunits and especially not in cylinders.

If compressors or compressor oils are to be removed, ensure that they have been evacuated to an acceptable level to make certain that flammable refrigerant does not remain within the lubricant. The evacuation process shall be carried out prior to returning the compressor to the suppliers. Only electric heating to the compressor body shall be employed to accelerate this process.When oil is drained from a system,it shall be carried out safely.

COMPETENCE OF SERVICE PERSONNEL

General

Special training additional to usual refrigerating equipment repair procedures is required when equipment with flammable refrigerants is affected.

In many countries, this training is carried out by national training organisations that are accredited to teach the relevant national competency standards that may be set in legislation.

The achieved competence should be documented by a certificate.

Training

The training should include the substance of the following:

Information about the explosion potential of flammable refrigerants to show that flammables may be dangerous when handled without care.

Information about potential ignition sources, especially those that are not obvious, such as lighters, light switches, vacuum cleaners, electric heaters.

Information about the different safety concepts:

Unventilated – (see Clause GG.2) Safety of the appliance does not depend on ventilation of the housing. Switching off the appliance or opening of the housing has no significant effect on the safety. Nevertheless, it is possible that leaking refrigerant may accumulate inside the enclosure and flammable atmosphere will be released when the enclosure is opened.

Ventilated enclosure – (see Clause GG.4) Safety of the appliance depends on ventilation of the housing. Switching off the appliance or opening of the enclosure has a significant effect on the safety. Care should be taken to ensure a sufficient ventilation before.

Ventilated room – (see Clause GG.5) Safety of the appliance depends on the ventilation of the room. Switching off the appliance or opening of the housing has no significant effect on the safety. The ventilation of the room shall not be switched off during repair procedures.

Information about the concept of sealed components and sealed enclosures according to IEC 60079-15:2010.

Information about the correct working procedures:

a) Commissioning

- Ensure that the floor area is sufficient for the refrigerant charge or that the ventilation duct is assembled in a correct manner.
- Connect the pipes and carry out a leak test before charging with refrigerant.
- Check safety equipment before putting into service.

b) Maintenance

- Portable equipment shall be repaired outside or in a workshop specially equipped for servicing units with flammable refrigerants.
- Ensure sufficient ventilation at the repair place.
- Be aware that malfunction of the equipment may be caused by refrigerant

loss and a refrigerant leak is possible.

- Discharge capacitors in a way that won't cause any spark. The standard procedure to short circuit the capacitor terminals usually creates sparks.
- Reassemble sealed enclosures accurately. If seals are worn, replace them.
- Check safety equipment before putting into service.

c) Repair

- Portable equipment shall be repaired outside or in a workshop specially equipped for servicing units with flammable refrigerants.
- Ensure sufficient ventilation at the repair place.
- Be aware that malfunction of the equipment may be caused by refrigerant loss and a refrigerant leak is possible.
- Discharge capacitors in a way that won't cause any spark.
- When brazing is required, the following procedures shall be carried out in the right order:
 - Remove the refrigerant. If the recovery is not required by national regulations, drain the refrigerant to the outside. Take care that the drained refrigerant will not cause any danger. In doubt, one person should guard the outlet. Take special care that drained refrigerant will not float back into the building.
 - Evacuate the refrigerant circuit.
 - Purge the refrigerant circuit with nitrogen for 5 min.
 - Evacuate again.
 - Remove parts to be replaced by cutting, not by flame.
 - Purge the braze point with nitrogen during the brazing procedure.
 - Carry out a leak test before charging with refrigerant.
 - Reassemble sealed enclosures accurately. If seals are worn, replace them.
 - Check safety equipment before putting into service.

d) Decommissioning

- If the safety is affected when the equipment is putted out of service, the refrigerant charge shall be removed before decommissioning.
- Ensure sufficient ventilation at the equipment location.
- Be aware that malfunction of the equipment may be caused by refrigerant loss and a refrigerant leak is possible.
- Discharge capacitors in a way that won't cause any spark.
- Remove the refrigerant. If the recovery is not required by national regulations, drain the refrigerant to the outside. Take care that the drained refrigerant will not cause any danger. In doubt, one person should guard the outlet. Take special care that drained refrigerant will not float back into the building.
- Evacuate the refrigerant circuit.
- Purge the refrigerant circuit with nitrogen for 5 min.
- Evacuate again.
- Fill with nitrogen up to atmospheric pressure.
- Put a label on the equipment that the refrigerant is removed.

e) Disposal

- Ensure sufficient ventilation at the working place.
- Remove the refrigerant. If the recovery is not required by national regulations, drain the refrigerant to the outside. Take care that the drained refrigerant will not cause any danger. In doubt, one person should guard the outlet. Take special care that drained refrigerant will not float back into the building.
- Evacuate the refrigerant circuit.
- Purge the refrigerant circuit with nitrogen for 5 min.
- Evacuate again.
- Cut out the compressor and drain the oil.

Transportation, marking and storage for units that employ flammable refrigerants

Transport of equipment containing flammable refrigerants

Attention is drawn to the fact that additional transportation regulations may exist with respect to equipment containing flammable gas. The maximum number of pieces of equipment or the configuration of the equipment, permitted to be transported together will be determined by the applicable transport regulations.

Marking of equipment using signs

Signs for similar appliances used in a work area generally are addressed by local regulations and give the minimum requirements for the provision of safety and/or health signs for a work location.

All required signs are to be maintained and employers should ensure that employees receive suitable and sufficient instruction and training on the meaning of appropriate safety signs and the actions that need to be taken in connection with these signs.

The effectiveness of signs should not be diminished by too many signs being placed together.

Any pictograms used should be as simple as possible and contain only essential details.

Disposal of equipment using flammable refrigerants

See national regulations.

Storage of equipment/appliances

The storage of equipment should be in accordance with the manufacturer's instructions.

Storage of packed (unsold) equipment

Storage package protection should be constructed such that mechanical damage to the equipment inside the package will not cause a leak of the refrigerant charge.

The maximum number of pieces of equipment permitted to be stored together

will be determined by local regulations.

- Disconnect the appliance from its power source during service and when replacing parts and cleaning.
- Please note: Check the nameplate for the type of refrigerant gas used in your appliance.

● Specific information regarding appliances with refrigerant gas.

The appliance is recommended not to pierce the cooling circuit of the machine. At the end of its useful life, deliver the appliance to a special waste collection centre for disposal.

GWP(Global Warming Potential): R410A: 2088, R134a: 1430, R290: 3, R32: 675.

● Do not use this unit for functions other than those described in this instruction manual.

● Make sure the plug is plugged firmly and completely into the outlet. It can result in the risk of electric shock or fire.

● Do not plug other appliances into the same outlet, it can result in the risk of electric shock.

● Do not disassemble or modify the appliance or the power cord, it can result in the risk of electric shock or fire. All other services should be referred to a qualified technician.

● Do not place the power cord or appliance near a heater, radiator, or other heat source. It can result in the risk of electric shock or fire.

● This unit is equipped with a cord that has a earthed wire connected to an earthed pin or grounding tab. The plug must be plugged into a socket that is properly installed and earthed. Do not under any circumstances cut or remove the earthed pin or grounding tab from this plug.

● The unit should be used or store in such a way that it is protected from moisture e.g. condensation, splashed water, etc. Unplug unit immediately if this occurs.

● Always transport your appliance in a vertical position and place on a stable, level surface during use. If the unit is transported laying on its side it should be stood up and left unplugged for 6 hours.

● Always use the switch on the control panel or remote controller to turn the unit off, and do not start or stop operation by plugging in or unplugging the power cord. It can result in the risk of electric shock.

● Do not touch the buttons on the control panel with your wet and damp fingers.

● Do not use hazardous chemicals to clean or come into contact with the unit.

To prevent damage to the surface finish, use only a soft cloth to clean the appliance. Do not use wax, thinner, or a strong detergent. Do not use the unit in the presence of inflammable substance or vapour such as alcohol, insecticides, gasoline, etc.

● If the appliance is making unusual sounds or is emitting smoke or an unusual odor, unplug it immediately.

- Do not clean the unit with water. Water can enter the unit and damage the insulation, creating a shock hazard. If water enters the unit, unplug it immediately and contact Customer Service.
- Utilize two or more people to lift and install the unit.
- Always grasp the plug when plugging in or unplugging the appliance. Never unplug by pulling on the cord. It can result in the risk of electrical shock and damage.
- Install the appliance on a sturdy, level floor capable of supporting up to 110lbs(50kg). Installation on a weak or unlevel floor can result in the risk of property damage and personal injury.
- The appliance is compliant with the RE Directive (2014/53/EU).

According the EN standard:

- This appliance can be used by children aged from 8 years and above and persons with reduced physical, sensory or mental capabilities or lack of experience and knowledge if they have been given supervision or instruction concerning use of the appliance in a safe way and understand the hazards involved.
- Children shall not play with the appliance.
- Cleaning and user maintenance shall not be made by children without supervision.
- If the supply cord is damaged, it must be replaced by the manufacturer, its service agent or a similarly qualified person in order to avoid a hazard.
- The appliance shall be installed in accordance with national wiring regulations.
- When the fuse is blown/circuit breaker is tripped, check the house fuse/circuit breaker box and replace fuse or reset breaker.

ELECTRICAL CONNECTIONS

Before plugging the appliance into the mains socket, check that:



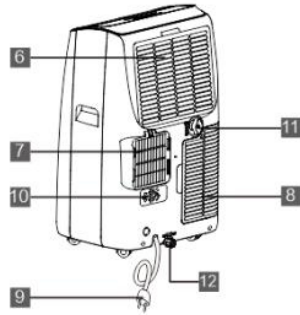
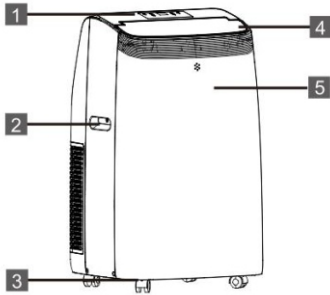

- The mains power supply corresponds to the value indicated on the rating plate on the back of the appliance.
- The power socket and electrical circuit are adequate for the appliance.
- The mains socket matches the plug. If this is not the case, have the plug replaced.
- The mains socket is adequately earthed. Failure to follow these important safety instructions absolves the manufacturer of all liability.

DESCRIPTION



1. Control panel	7. Air outlet grille
2. Handle (both sides)	8. Intake grille
3. Castors	9. Power cable
4. Deflector	10. Plug fixer
5. Remote control receiver	11. Middle drainage
6. Intake grille	12. Condenser drain

ACCESSORIES

PARTS	PARTS NAME	QUANTITY
	Exhaust hose Hose outlet Hose inlet	1 set
	Window slider kit	1 set
	Remote Control Batteries (Two AAA 1.5V)	1 set
	Drain Hose	1 set

NOTE: All the illustrations in this manual are for explanatory purposes only. Your appliance may be slightly different. Be sure all accessories are removed from the packing before use.

INSTALLATION INSTRUCTIONS

EXHAUSTING HOT AIR

In the Cool Mode the appliance must be placed close to a window or opening so that the warm exhaust air can be ducted outside.

First position unit on a flat floor and make sure there's a minimum of 18"(45cm) clearance around the unit, and is within the vicinity of a single circuit outlet power source.

1 .Extend either side of the hose (Fig.1)and screw the hose inlet (Fig.2).

2 .Extend the other side of the hose and screw it to the hose outlet (Fig.3).

3 .Install the hose inlet into the unit (Fig.4).

4 .Affix the hose outlet into the window slider kit and seal. (Fig.5 &6).

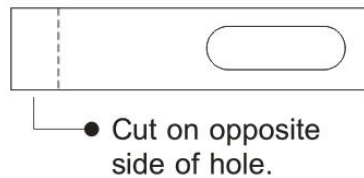
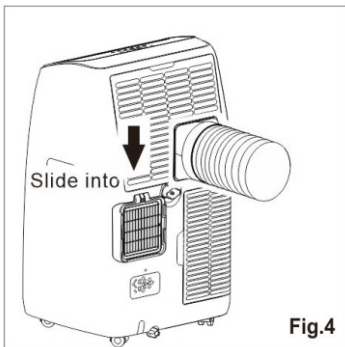
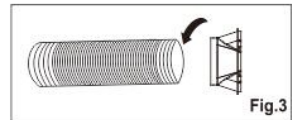
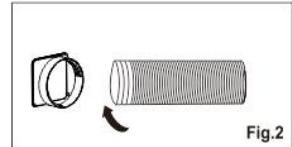
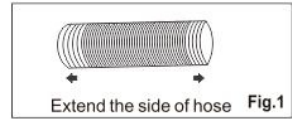

Your window slider kit has been designed to fit most standard vertical and horizontal window applications, however, it may be necessary for you to modify some aspects of the installation procedures for certain types of windows. The window slider kit can be fastened with screws.

NOTE: If the window opening is less than the minimum length of the window slider kit, cut the end without the hold in it short enough to fit in the window opening. Never cut out the hole in window slider kit.

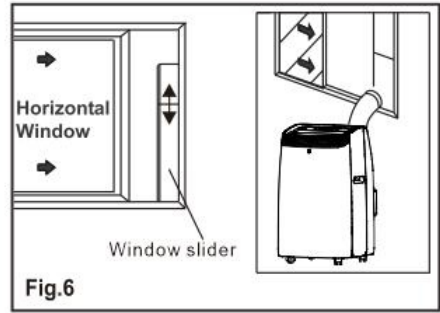
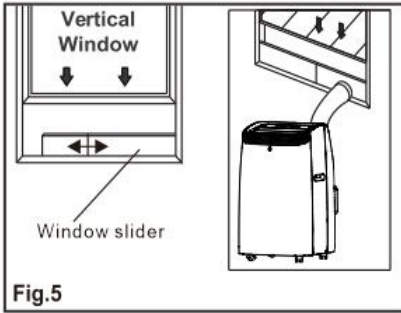

WINDOW SLIDER KIT INSTALLATION

1: Parts:

- A) Panel
- B) Panel with one hole
- C) Screw to lock window kit in place

2: Assembly:

Slide Panel B into Panel A and size to window width. Windows sizes vary. When sizing the window width, be sure that the window kit assembly is free from gaps from gaps and/or air pockets when taking measurements.

3: Lock the screw into the holes that correspond.

With the width that your window requires to ensure that there are no gaps or air pockets in the window kit assembly after installation.

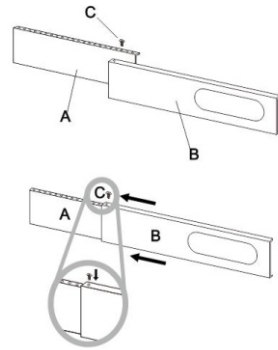

LOCATION

- The unit should be placed on a firm foundation to minimize noise and vibration. For safe and secure positioning, place the unit on a smooth, level floor strong enough to support the unit.
- The unit has casters to aid placement, but it should only be rolled on smooth, flat surfaces. Use caution when rolling on carpeted surfaces. Use caution and Protect floors when rolling over wood floors. Do not attempt to roll the unit over objects.
- The unit must be placed within reach of a properly rated grounded socket.
- Never place any obstacles around the air inlet or outlet of the unit.
- Allow at least 18”(45cm) of around and above space away from the wall for efficient working.
- The hose can be extended, but it is the best to keep the length to minimum required. Also make sure that the hose does not have any sharp bends or sags.

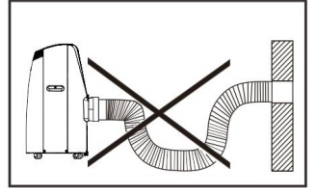
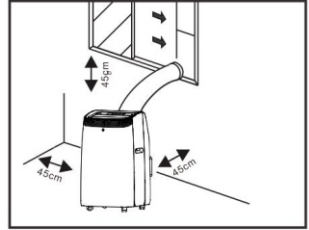

DESCRIPTION OF THE DISPLAY SCREEN

The control panel is on the top of the appliance, enables you to manage part functions without remote controller, but to fully exploit its potential, you must use the remote controller.

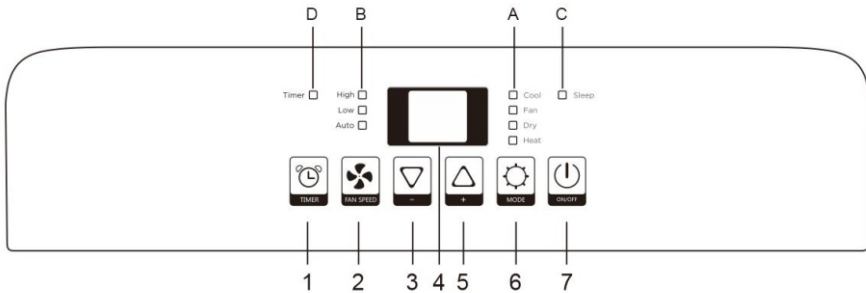

- | | |
|--------------------|--------------------|
| 1.Timer button | A Mode symbol * |
| 2.Fan speed button | B Fan speed symbol |
| 3.Decrease button | C Sleep symbol |
| 4.Display screen | D Timer symbol |
| 5.Increase button | |
| 6.MODE button | |
| 7.ON/OFF button | |

“ * ” means the heat symbol only the heat pump model have this function.

TURNING THE APPLIANCE ON

Plug into the mains socket, then the appliance is standby.

Press the  button to make the appliance turn on. The last function active when it was turned off will appear.





COOL mode

Ideal for hot muggy weather when you need to cooling and dehumidify the room.

To set this mode correctly:

- Press the  button a number of times until the “Cool” symbol appears.



- Select the target temperature 18°C-32°C(64°F-90°F) by pressing the  or .

button until the corresponding value is displayed.

- Select the required fan speed by pressing the  button.
Three speeds are available: High / Low / Auto.



The most suitable temperature for the room during the summer varies from 24°C to 27°C (75°F to 81°F). You are recommended, however, not to set a temperature much below the outdoor temperature. The fan speed difference is more noticeable when the appliance is under Fan mode but may not be noticeable under Cool mode.

HEAT mode *

* * means only the heat pump model have this function.



To set this mode correctly:



- Press the  button a number of times until the Heat symbol appears.
- Select the target temperature 13°C-27°C (55°F-81°F) by pressing the Δ or ∇ button until the corresponding value is displayed.
- Select the required fan speed by pressing the  button.
Three speeds are available: High / Low / Auto.
- Water is removed from the air and collected in the tank.
- When the tank is full, the appliance shuts down and “” (full tank) appears on the display. The tank cap must be extracted and emptied water. Run off all water left into a basin. When all the water has been drained, put the cap back in place.
- When the tank has been emptied, the appliance starts up again.



NOTE:

- When operating in very cold rooms, the appliance defreezes automatically, momentarily interrupting normal operation. During this operation, it is normal for the noise made by the appliance to change.
- In this mode, you may have to wait for a few minutes before the appliance starts giving out hot air.

FAN mode

When using the appliance in this mode, the air hose does not need to be attached.

- Press the  button a number of times until the “Fan” symbol appears.
- Select the required fan speed by pressing the  button.
Two speeds are available: High / Low.

The screen display “” as high speed, “” as low speed.

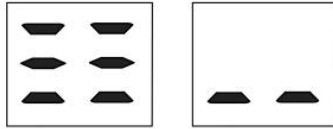



DRY mode

Ideal to reduce room humidity (spring and autumn, damp rooms rainy periods, etc).

In dry mode, the appliance should be prepared in the same way as for cool mode, with the air exhaust hose attached to enable the moisture to be discharged outside.



To set this mode correctly:

- Press the  button a number of times until the Dry symbol appears. The screen display “”.
- In this mode, fan speed is selected automatically by the appliance and can not be set manually.

SMART mode

The appliance chooses automatically whether to operate in cool, fan or heat (certain models only) mode.

To set this mode correctly:

- Press the  button a number of times until the screen show like below:

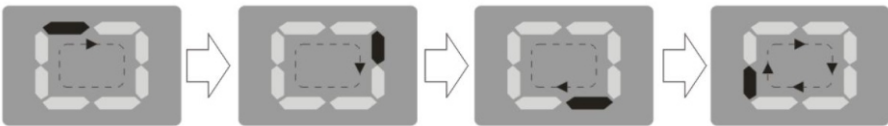

- Select the required fan speed by pressing the  button.
Three speeds are available: High / Low / Auto.

If the appliance is cooling only model, the unit operates in Fan mode when the room temperature is below 23°C (73°F), and Cool mode when the room temperature is above 23°C(73°F).

If the appliance is cooling and heating model, the unit operates in Heat mode when the room temperature is below 20°C(68°F), and Fan mode when the room temperature is from 20°C (68°F) to 23°C(73°F), and Cool mode when the

room temperature is above 23°C (73°F).

SETTING THE TIMER

-This timer can be used to delay the appliance start-up or shutdown, this avoids wasting electricity by optimizing operating periods.

* Programming start-up

- Turn on the appliance, choose the mode you want, for example Dehumidify mode, high fan speed. Turn off the appliance.

- Press the "" button , the screen starts to flash, press the " Δ " / " ∇ " to adjust the set time from 0.5-24 hours.

- In 5 seconds without the operation, the timer start function, then the "Timer" symbol lights.

- Press the "" button again to cancel the Timer, and the "Timer" symbol disappear.

* Programming shut down

- When the appliance is running, press the "" button, the screen starts to flash. - Press the " Δ " / " ∇ " to adjust the set time from 0.5-24 hours.

- In 5 seconds without the operation, the timer start function, then the " Timer" symbol lights.

- Press the "" button again to cancel the Timer, and the " Timer " symbol disappear.

SWITCH THE UNIT OF TEMPERATURE

When the appliance is running, hold on " Δ " and " ∇ " button together 3 seconds by the same time, then you can change the unit of temperature.

For example:

Before change, in cool mode, the screen display like fig1.

After change, in cool mode, the screen display like fig2.



Fig.1





Fig.2

The following functions below are optional. Please refer to the real object, just because these functions only belong to some model.

SELF-DIAGNOSIS

The appliance has a self diagnosis system to identify a number of malfunctions.

Error messages are displayed on the appliance display.

IF IS DISPLAYED	WHAT SHOULD I DO?
 <p>PROBE FAILURE (sensor damaged)</p>	<p>If this is displayed, contact your local authorize service centre.</p>
 <p>FULL TANK (safety tank full)</p>	<p>Empty the internal safety tank, following the instructions in the "End of season operations" paragraph.</p>

REMOTE CONTROL

		On/Off button		Fan speed button
		Increase button		Mode button
		Decrease button		Swing button
		Timer button		Sleep button
	°C/°F	Unit Switch button		

- ✓ Point the remote control at the receiver on the appliance.
- ✓ The remote control must be no more than 7 meters away from the appliance (without obstacles between the remote control and the receiver).
- ✓ The remote control must be handled with extreme care. Do not drop it or expose it to direct sunlight or sources of heat. If the remote control do not work, please try to take out the battery, and put it back again.

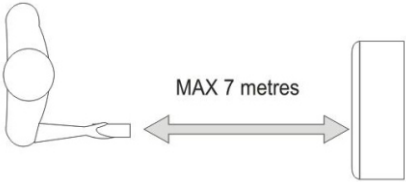

INSERTING OR REPLACING THE BATTERIES

- Remove the cover on the rear of the remote control;
- Insert two "AAA" 1.5V batteries in the correct position (see instructions inside the battery compartment);



NOTE:

- ✓ If the remote control unit is replaced or disposed of, the batteries must be removed and discarded in accordance with current legislation as they are harmful to the environment.
- ✓ Do not mix old and new batteries. Do not mix alkaline, standard

(carbon-zinc) or rechargeable (nickel-cadmium) batteries.

√ Do not dispose of batteries in fire. Batteries may explode or leak.



√ If the remote control is not be used for a certain length of time, remove the batteries.

COOL mode

Ideal for hot muggy weather when you need to cooling and dehumidify the room.



To set this mode correctly:

- Press the  button a number of times until the “Cool” symbol light appears.
- Select the target temperature 18°C-32°C (64°F-90°F) by pressing the “^” or “v” button until the corresponding value is displayed.
- Select the required fan speed by pressing the  button.
Three speeds are available: High / Low / Auto.



The most suitable temperature for the room during the summer varies from 24°C to 27°C(75°F to 81°F). You are recommended, however, not to set a temperature much below the outdoor temperature. The fan speed difference is more noticeable when the appliance is under FAN mode but may not be noticeable under COOL mode.

HEAT mode *

* * means only the heat pump model have this function.



To set this mode correctly:

- Press the  button a number of times until the “Heat” symbol appears.
- Select the target temperature 13°C-27°C(55°F-81°F) by pressing the ^ or v button until the corresponding value is displayed.
- Select the required fan speed by pressing the  button.
Three speeds are available: High / Low / Auto.
- Water is removed from the air and collected in the tank.
- When the tank is full, the appliance shuts down and “ FT ”(full tank) appears on the display. The tank cap must be extracted and emptied water. Run off all water left into a basin. When all the water has been drained, put the cap back

in place.



- When the tank has been emptied, the appliance starts up again.



NOTE :

- When operating in very cold rooms, the appliance defreezes automatically, momentarily interrupting normal operation. During this operation, it is normal for the noise made by the appliance to change.
- In this mode, you may have to wait for a few minutes before the appliance starts giving out hot air.
- In this mode, the fan may operate for short periods, even though the set temperature has already been reached.

FAN mode

When using the appliance in this mode, the air hose does not need to be attached.

- Press the  button a number of times until the “Fan” symbol appears.
- Select the required fan speed by pressing the  button.
Two speeds are available: High / Low.

The screen display “” as high speed, “” as low speed.



DRY mode

Ideal to reduce room humidity (spring and autumn, damp rooms rainy periods, etc).

In dry mode, the appliance should be prepared in the same way

as for cool mode, with the air exhaust hose attached to enable

the moisture to be discharged outside.

To set this mode correctly:

- Press the  button a number of times until the “Dry” symbol appears.



- In this mode, fan speed is selected automatically by the appliance and can not be set manually.

SMART mode

The appliance chooses automatically whether to operate in cool, fan or heat mode (some certain models have not heat mode).

To set this mode correctly:

- Press the  button a number of times until the screen display like below:

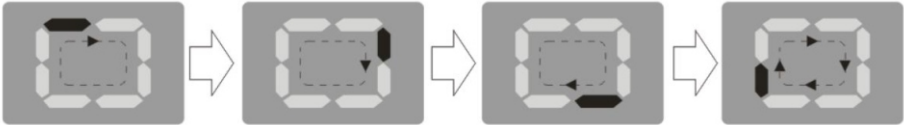

It is AUTO mode when the display will be running circulating.

- Select the required fan speed by pressing the  button. Three speeds are available: High / Low / Auto.



If the appliance is cooling only model, the unit operates in Fan mode when the room temperature is below 23°C (73°F), and Cool mode when the room temperature is above 23°C (73°F).

If the appliance is cooling and heating model, the unit operates in Heat mode when the room temperature is below 20°C (68°F), and Fan mode when the room temperature is from 20°C (68°F) to 23°C (73°F), and Cool mode when the room temperature is above 23°C (73°F).

SWING function

This function moves the deflectors to adjust the direction of the air flow.

To set this function correctly:

- Press the  button to select the horizontal deflector to automatically move up and down.
- Press the  button again to switch off this function.



SLEEP function

This function is useful for the night as it gradually reduces operation of the appliance.

To set this function correctly:

- Select the cool or heat mode as described above.

- Press the  button.

The appliance operates in the previously selected mode.

When you choose the sleep function, the screen will reduce the brightness, and the fan speed is low.

The SLEEP function maintains the room at optimum temperature without excessive fluctuations in either temperature or humidity with silent operation. Fan speed is always at Low, while room temperature and humidity vary gradually to ensure the most comfortable.

When in COOL mode, the selected temperature will increase by 1°C (1°F) per hour in a 2 hour period. This new temperature will be maintained for the next 6 hours. Then the appliance turn it off.

When in HEAT mode, the selected temperature will decrease by 1°C (1°F) per hour in a 3 hour period. This new temperature will be maintained for the next 5 hours. Then the appliance turn it off.

The SLEEP function can be canceled at any time during operation by pressing the "Sleep", "Mode" or "fan speed" button.

In DRY and SMART mode, SLEEP function is still available.

SETTING THE TIMER

-This timer can be used to delay the appliance startup or shutdown, this avoids wasting electricity by optimising operating periods.

* Programming start-up

- Turn on the appliance, choose the mode you want, for example Dehumidify mode, high fan speed. Turn off the appliance.

- Press the "  " button , the screen starts to flash, press the "∧" or "∨" to adjust the set time from 0.5-24 hours.

- In 5 seconds without the operation, the timer start function, then the "Timer" symbol lights.

- Press the "  " button button again to cancel the Timer, and the "Timer" symbol disappear.

* Programming shut down

- When the appliance is running, press the "  " button, the screen starts to

flash, press the " ^ " / " v " to adjust the set time from 0.5-24 hours.

- In 5 seconds without the operation, the timer start function, then the " Timer " symbol lights.

- Press the "  " button again to cancel the Timer, and the " Timer " symbol disappear.

SWITCH THE UNIT OF TEMPERATURE

When the appliance is running, press the °C/°F button, then you can change the unit of temperature.

For example:

Before change, in cool mode, the screen display like fig left.

After change, in cool mode, the screen display like fig right.



Fig.1



Fig.2

TIPS FOR CORRECT USE

To get the best from your appliance, follow these recommendations:

- Close the windows and doors in the room to be air conditioned (fig.11).

When installing the appliance semi-permanently, you should leave a door slightly open (as little as 1 cm) to guarantee correct ventilation;

- Protect the room from direct exposure to the sun by partially closing curtains and/or blinds to make the appliance much more economical to run (fig. 12);

- Never rest objects of any kind on the appliance; (fig. 13)

- Do not block the air inlet or outlet of the appliance. Reduced air flow will result in poor performance and could damage the unit.

- Make sure there are no heat sources in the room;

- Never use the appliance in very damp rooms (laundries for example).

- Never use the appliance outdoors.

- Make sure the appliance is standing on a level surface.

If necessary, place the castor locks under the front wheels.

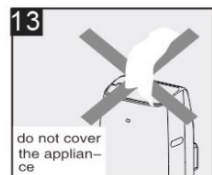
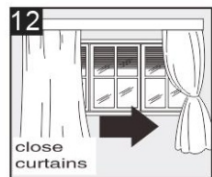
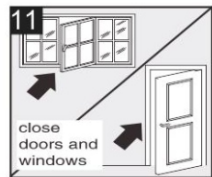

WATER DRAINAGE METHOD

When there is excess water condensation inside the unit, the appliance stops running and shows “ F t ” (FULL TANK as mentioned in SELF-DIAGNOSIE). This indicates that the water condensation needs to be drained using the following procedures:

Manual Draining (fig.14)

Water may need to be drained in high humidity areas

- 1 .Unplug the unit from power source.
2. Place a drain pan under the lower drain plug. See diagram.
3. Remove the lower drain plug.
4. Water will drain out and collect in the drain pan (maybe not supplied).
5. After the water is drained, replace the lower drain plug firmly.
- 6.Turn on the unit.

Continuous Draining (fig.15)

While using the unit in dehumidifier mode, continuous drainage is recommended.

- 1 .Unplug the unit from the power source.
2. Remove the drain plug. While doing this operation some residual water may spill so please have a pan to collect the water.
3. Connect the drain hose (1/2" or 12.7mm, maybe not supplied). See diagram.
4. The water can be continuously drained through the hose into a floor drain or bucket.
5. Turn on the unit.

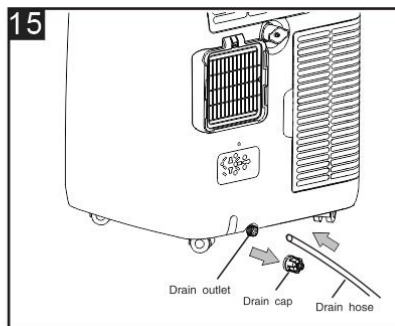
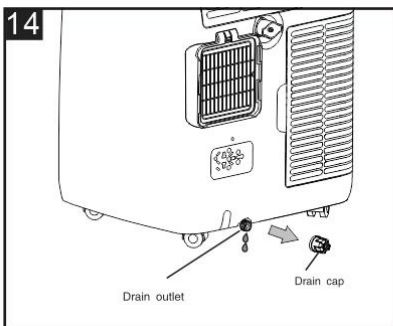

NOTE:

Please be sure that the height of and section of the drain hose should not be higher than that of the drain outlet, or the water tank may not be drained. (fig.16 and fig.17)

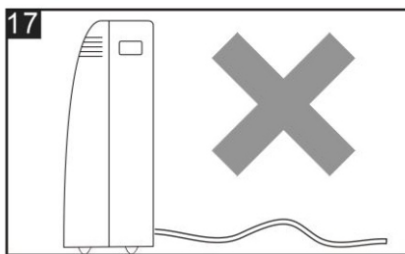
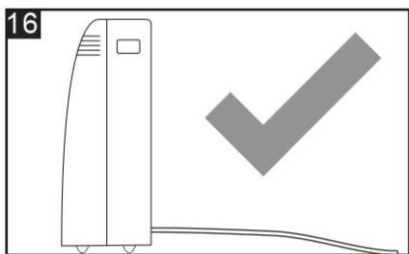

Middle drainage

When unit running in Dry mode, you can choose the way below to drainage.

1. Unplug the unit from the power source.
2. Remove the drain plug(fig A). While doing this operation some residual water may spill so please have a pan to collect the water.
3. Connect the drain hose (1/2" or 12.7mm, maybe not supplied). (fig B)
4. The water can be continuously drained through the hose into a floor drain or bucket.
5. Turn on the unit.

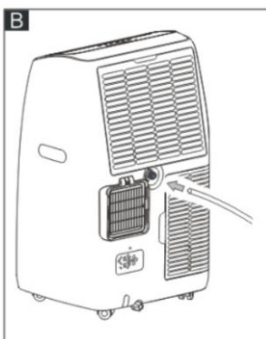

NOTE:

Please be sure that the height of and section of the drain hose should not be higher than that of the drain outlet, or the water tank may not be drained. (fig.C and fig.D)

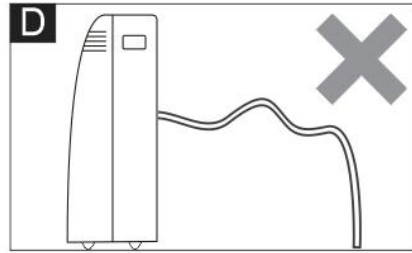
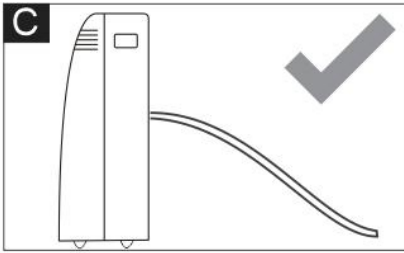

CLEANING

Before cleaning or maintenance, turn the appliance off by pressing the  button on the control panel or remote control, wait for a few minutes then unplug from the mains socket.

CLEANING THE CABINET

You should clean the appliance with a slightly damp cloth then dry with a dry cloth.

- Never wash the appliance with water. It could be dangerous.
- Never use petrol, alcohol or solvents to clean the appliance.
- Never spray insecticide liquids or similar.

CLEANING THE AIR FILTERS

To keep your appliance working efficiently, you should clean the filter every week of operation.

The filter can take out like fig below.

To avoid possible cuts, avoid contacting the metal parts of the appliance when removing or re-installing the filter. It can result in the risk of personal injury.

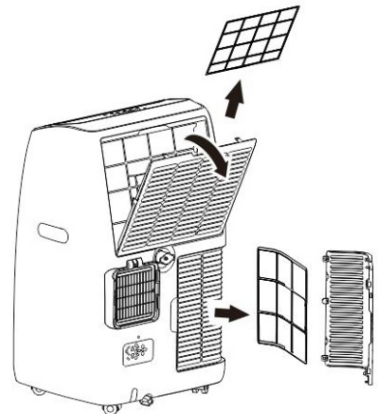

Use a vacuum cleaner to remove dust accumulations from the filter. If it is very dirty, immerse in warm water and rinse a number of times. The water should never be hotter than 40°C (104°F). After washing, leave the filter to dry then attach the intake grille to the appliance.

START - END OF SEASON OPERATIONS

START OF SEASON CHECKS

Make sure the power cable and plug are undamaged and the earth system is efficient.

Follow the installation instructions precisely.

END OF SEASON OPERATIONS

To empty the internal circuit completely of water, remove the cap.

Run off all water left into a basin. When all the water has been drained, put the cap back in place.

Clean the filter and dry thoroughly before putting back.

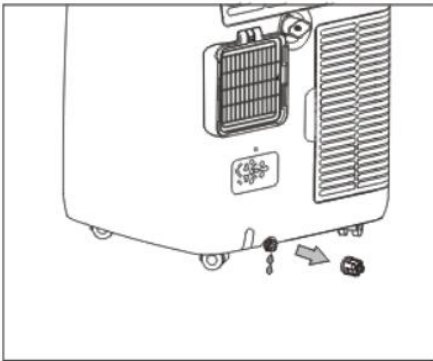

Strictest operation environment:

Cooling mode: 18°C-35°C (64°F-95°F) , 30%RH~90%RH

Heating mode: 10°C-25°C (50°F-77°F) , 30%RH~90%RH

TROUBLESHOOTING

PROBLEM	CAUSE	SOLUTION
The appliance does not come on	<ul style="list-style-type: none"> ● There is no current ● It is not plugged into the mains ● The internal safety device has tripped 	<ul style="list-style-type: none"> ● Wait ● Plug into the mains ● Wait 30 minutes, if the problem persists, contact your service center
The appliance works for a short time only	<ul style="list-style-type: none"> ● Here are bends in the air exhaust hose ● Something is preventing the air from being discharged 	<ul style="list-style-type: none"> ● Position the air exhaust hose correctly, keeping it as short and free of curves as possible to avoid bottlenecks ● Check and remove any obstacles obstructing air discharge
The appliance works, but does not cool the room	<ul style="list-style-type: none"> ● Windows, doors and/or curtains open 	<ul style="list-style-type: none"> ● Close doors, windows and curtains, bearing in mind the "tips for correct use" given above
	<ul style="list-style-type: none"> ● There are heat sources in the room (oven, hairdryer, etc) 	<ul style="list-style-type: none"> ● Eliminate the heat sources
	<ul style="list-style-type: none"> ● The air exhaust hose is detached from the appliance 	<ul style="list-style-type: none"> ● Fit the air exhaust hose in the housing at the back of the appliance
	<ul style="list-style-type: none"> ● The technical specification of the appliance is not adequate for the room in which it is located 	
During operation, there is an unpleasant smell in the room	<ul style="list-style-type: none"> ● Air filter clogged 	<ul style="list-style-type: none"> ● Clean the filter as described above

<p>The appliance does not operate for about three minutes after restarting it</p>	<ul style="list-style-type: none"> • The internal compressor safety device prevents the appliance from being restarted until three minutes have elapsed since it was last turned off 	<ul style="list-style-type: none"> • Wait. This delay is part of normal operation
<p>The following message appears on the display: PF / FE</p>	<ul style="list-style-type: none"> • The appliance has a self diagnosis system to identify a number of malfunctions 	<ul style="list-style-type: none"> • See the SELF-DIAGNOSIS Chapter